











33 816 875



- saillie 241 mm
- bec pivotant 360°
- jet enrichi en air
- hauteur de robinetterie 393 mm
- hauteur jusqu'au mousseur 240 mm
- diamètre de percement 35 mm
- débit d'eau maxi. 8 l/min avec une pression d'écoulement de 3 bars
- sans plomb
- Ce produit contribue au respect des exigences des systèmes d'évaluation des bâtiments écologiques, par exemple LEED®, BREEAM®, DGNB

	Champagne (Or 22cts)	33 816 875-47
	Chrome	33 816 875-00
	Platine brossé	33 816 875-06
	Platine	33 816 875-08
	Laiton (Or 23cts)	33 816 875-09
	Dark Chrome	33 816 875-19
	Laiton brossé (Or 23cts)	33 816 875-28
	Noir mat	33 816 875-33
	Champagne brossé (Or 22cts)	33 816 875-46
	Chrome brossé	33 816 875-93
	Dark Platinum brossé	33 816 875-99

Accessoires recommandés

**Distributeur sans rosace - Champagne (Or 22cts)** 82 424 970-47



Accessoires recommandés

**Commande de vidage individuelle manuelle Commande manuelle - Champagne (Or 22cts)** 10 712 970-47



33 816 875

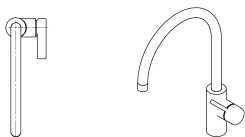
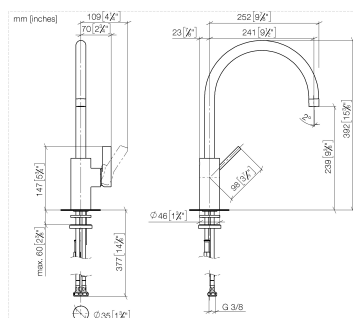

**Diagramme de débit**

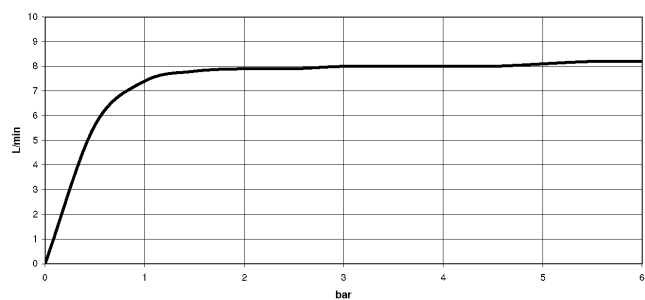

**Certificats**

GDV\_0400195.

LGA\_18899.

33 816 875

Les pièces pour les autres finitions peuvent être trouvées ici : [Chrome](#)

